

Packaging Information

(1) Reel Dimension

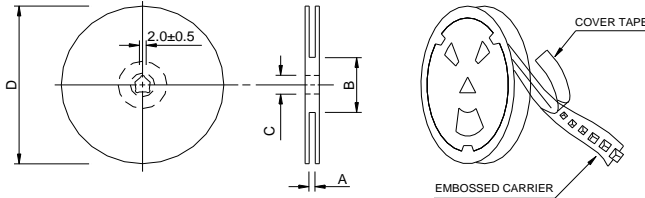

Type	A(mm)	B(mm)	C(mm)	D(mm)
13"x12mm	12.4+2/-0	100±2	13+0.5/-0.2	330

(2) Tape Dimension

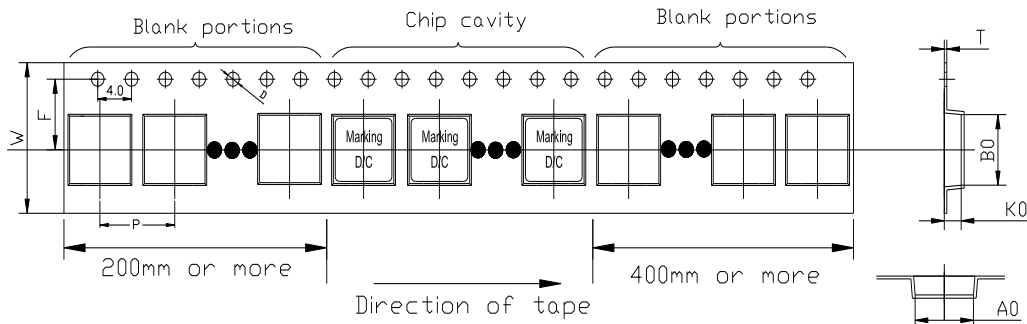

Ao(mm)	Bo(mm)	Ko(mm)	P(mm)	W(mm)	F(mm)	T(mm)	D(mm)
4.7±0.1	4.7±0.1	2.3±0.1	8.0±0.1	12±0.3	5.5±0.1	0.35±0.1	1.5±0.1

(3) Packaging Quantity

Size	Reel
JRPI 0402FV	3000

(4) Tearing Off Force

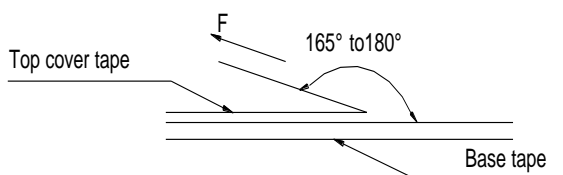

The force for tearing off cover tape is 10 to 130 grams in the arrow direction under the following conditions (referenced ANSI/EIA-481-D-2008 of 4.11 standard)

Tearing Speed mm	Room Temp. (°C)	Room Humidity (%)	Room atm (hPa)
300±10%	5~35	45~85	860~1060